

パッシブレピーターを用いた無線通信の伝搬実験

陳 強[†] 王 琳[†] 屈 世偉^{††} 袁 巧微^{†††} 澤谷 邦男[†]

[†] 東北大学大学院工学研究科電気・通信工学専攻 〒980- 8579 仙台市青葉区荒巻字青葉 6-6-05

^{††} 電子科技大学 〒610054 中国成都市成都市建設北路二段四号

^{†††} 仙台電波工業高等専門学校 〒989- 3128 仙台市青葉区愛子中央 4-16-1

E-mail: chenq@ecei.tohoku.ac.jp

あらまし パッチアンテナアレーと八木・宇田アレーから構成されるデュアルアンテナを設計し、試作する。アレー化したデュアルアンテナをパッシブレピーターとして無線通信の屋内環境に配置し、MIMO 伝送におけるチャンネル特性を測定することにより、パッシブレピーターによる MIMO 伝送特性の改善効果を明らかにする。

キーワード パッシブレピーター, MIMO, 無線通信, アンテナ, アンテナアレー.

Experimental Study on Improving Propagation Performance in Wireless Communications Using Passive Repeaters

Qiang CHEN[†], Lin WANG[†], Shiwei QU^{††}, Qiaowei YUAN^{†††},

and Kunio SAWAYA[†]

[†] Department of Electrical and Communication Engineering,
Graduate School of Engineering, Tohoku University
6-6-05 Aramaki-Aza-Aoba, Aoba-ku, Sendai 980- 8579 Japan

^{††} Univ. of Electrical Science and Tech. of China,
No.4, Section 2, North Jianshe Road, Chengdu, China

^{†††} Sendai National College of Technology,
4-16-1 Ayashi-chuo, Aoba-ku, Sendai 989- 3128 Japan

E-mail: chenq@ecei.tohoku.ac.jp

Abstract A passive repeater (PR), which comprises one 4-element folded-patch antenna (FPA) array, one planar Yagi-Uda array, and one power combiner, is fabricated to evaluate its performance in a multipath Multiple-Input Multiple-Output (MIMO) communication system experimentally. The received power and the MIMO channel capacity are extensively measured to illustrate the effectiveness of a 4-unit PR for improving the quality of communication channel in the MIMO environment.

Key words Passive repeater, MIMO, Wireless Communications, Antennas, Array Antennas.

1. Introduction

It is a severe problem that radio waves from base stations of cellular mobile systems are blocked by high and dense buildings in urban areas, especially in narrow streets, resulting in very weak signal level received by mobile terminals and poor communication quality. Many efforts have been made in order to eliminate the blind areas that dramatically degrades the efficiency of data transmission between mobile users and base stations due to poor receiving signal noise

ratio (SNR). Generally, if one of channels in a MIMO system is blocked, the total channel capacity may be reduced significantly. In cases where a direct microwave link cannot be established between two points (i.e., None-Line-of-Sight [NLOS] situations), it is possible to reconstruct the path by using a repeater. The primary function of such repeaters is to amplify and then relay the received EM signals so as to overcome or alleviate the blocking effects of various obstacles (e.g., buildings or mountains). Among them, passive repeaters (PR) are attractive candidates to be used in

MIMO system due to their lower cost of manufacturing, operation, and maintenance compared with traditional active repeaters [1], [2].

Recently, Li *et al.* designed a broadband reflectarray antenna as a PR to remove the blind areas [3]. However, the aperture efficiency of the reflectarray is greatly degraded when a very large scattering angle is desired because of physical limitations of the reflectarray. In [4], although a dual-antenna system (DAS) composed of a patch antenna array and an open-ended waveguide was proposed to realize a large scattering angle, there still exist disadvantages such as bulky size, high cost, and low equivalent bi-static radar cross section (BRCS), etc. In [5], a quasi-planar DAS was proposed to solve these problems, but the authors only provided numerical analyses. However, it is also important to demonstrate the effectiveness and reliability of the proposed DAS when used in practical applications.

In this report, a quasi-planar PR, which consists of one 4-element FPA array, one planar Yagi-Uda array, and one power combiner, was designed and fabricated. Experiments in a multi-path environment were then carried out to demonstrate the improvements of channel quality when the PR was incorporated into MIMO systems [6].

In the follows, the basic configuration of the fabricated PR is presented in Section II. The detailed measurement setup in a MIMO environment is described in Section III. Experimental results are shown in Section IV, and the improvements of the communication quality due to the usage of the proposed PR are discussed as well. Finally, some concluding remarks are given in Section V.

2. Configuration of passive repeater

Fig. 1 shows the configuration of one unit of the proposed PR. It comprises one 4-element FPA array, one planar Yagi-Uda array, and one power combiner. The element of the FPA array residing on the top substrate is chosen as the same as Set 1 in [7] due to its compact size. As is well known, there is a tradeoff between antenna's size and gain. Thus, if high gain is of primary concern in applications, other planar antenna types with slightly larger sizes can also be chosen to meet the requirement, such as the broadband patch antennas proposed in [8]. The adopted Yagi-Uda antenna has one driven element, two directors, and the ground plane acts as the reflector. The ground plane is corrugated periodically to suppress the side lobes in H plane, and the antenna gain can be enhanced effectively [9]. The power combiner is designed on the bottom substrate, connected to the driving port of the planar Yagi-Uda array. Feeding probes A, B, C, and D for the patch elements are connected to four input ports of the power combiner through the via holes through the

ground plane. When the incident wave impinges the FPA array, the received EM signal is delivered to the Yagi-Uda antenna through a power combiner for reradiating the signal with vertical polarization [5]. A 4-unit PR prototype was fabricated as shown in Fig. 2. In the design, the substrate with a thickness of 0.8 mm and relative permittivity 3.3 was utilized.

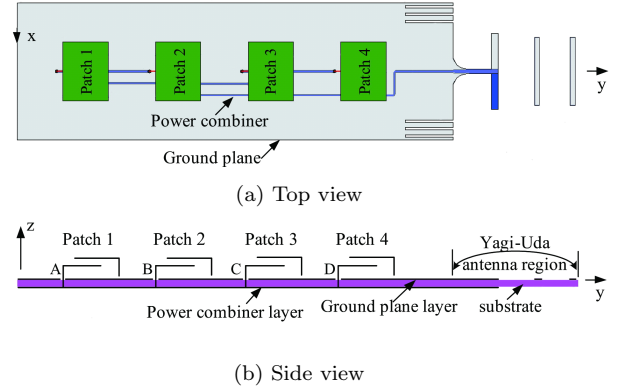
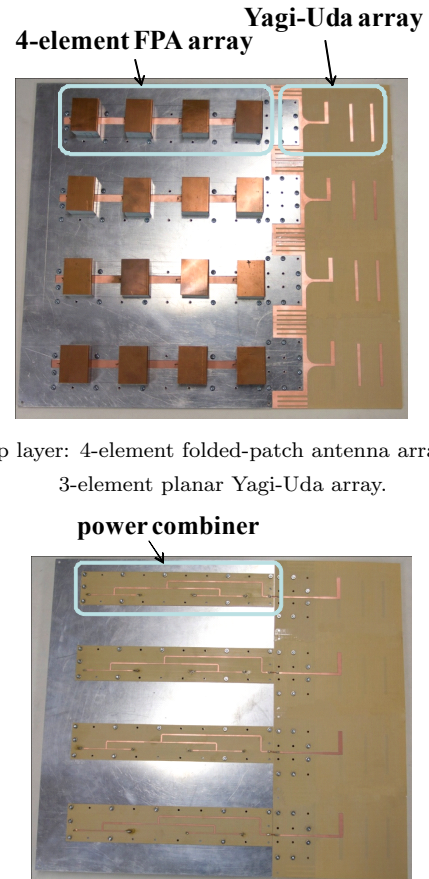

Figure 1 Configuration of one-unit PR.



(a) Top layer: 4-element folded-patch antenna array and a 3-element planar Yagi-Uda array.
(b) Bottom layer: Microstrip power combiner.
Figure 2 Photographs of the fabricated 4-unit PR.

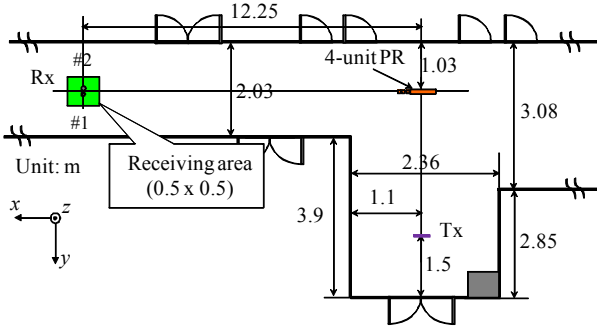

Figure 3 MIMO measurement environment.

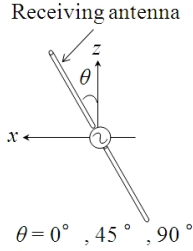

Figure 4 The polarization directions of the receiving antennas.

3. Measurement and results

A 2×2 MIMO system was constructed to demonstrate the effectiveness of the 4-unit PR for improving the quality of communication channel. The experiment was implemented inside a concrete building of our university as shown in Fig. 3, an NLOS environment which was constructed to simulate the environment in urban cities as shown in [3], [5] as a scale model. Two $\lambda/2$ dipole antenna arrays with 1.2λ array spacing were used as the transmitting antenna, and the transmitting signal was a continuous wave (CW) operating at 2 GHz. Agilent 89600S vector signal analyzer with two RF input channels were used to receive the signals from two $\lambda/2$ dipole antenna arrays with $\lambda/2$ array spacing. The location of transmitting antennas was fixed, while the receiving antenna was moved gradually by a step of 2.5 cm in a 50 cm \times 50 cm square area. Therefore, measurement was repeated 21×21 times. Distance between the center of the 4-unit PR and that of receiving area, d_1 , was 12.25 m. d_2 , the distance between the center of the 4-unit PR and the transmitting antenna, was 3.4 m. Ceiling height measured from floor was 2.42 m, while receiving antennas, the center of transmitting antennas, and the 4-unit PR were placed above the floor by the same height (1.21m). The transmitting antennas were fixed to radiate horizontally polarized signals, whereas the polarization directions of the receiving antennas varied from the vertical direction ($\theta = 0^\circ$) to the horizontal direction ($\theta = 90^\circ$) in the xoz plane as shown in Fig. 4 in order to investigate the effectiveness of the 4-unit PR for the practical

applications.

441 experimental results were obtained for various polarization directions and they were further expressed in the form of cumulative distribution function (CDF).

Fig. 5 shows the CDF of the received power with/without the 4-unit PR for $\theta = 45^\circ$. The results of Rx1 and Rx2 are denoted by solid line and short dash line, respectively. It can be seen that when the 4-unit PR is used, the medians of the received power of Rx1 and Rx2 are improved by about 14 dB, compared with the results without using the PR. We also find that the gradients of the fading of the channels are a few different with and without the 4-unit PR. The reason is that the use of the 4-unit PR could produce more pronounced multi-path effects than that of the system lack of the 4-unit PR, due to the field distribution variation in an indoor environment. In other words, the introduction of the proposed PR can generate more uncorrelated signals and brings benefit for the communication system.

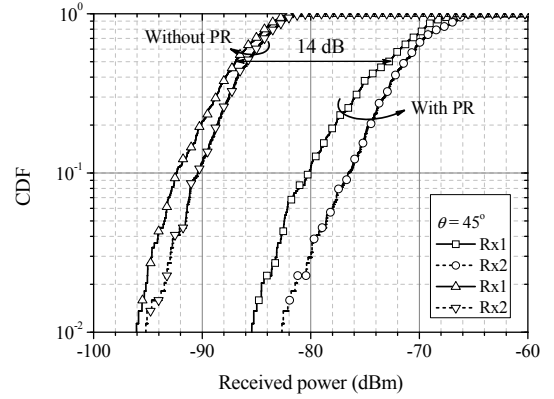

Figure 5 The CDF of the received power with/without 4-unit PR for $\theta = 45^\circ$ (received noise level=-120 dBm/Hz).

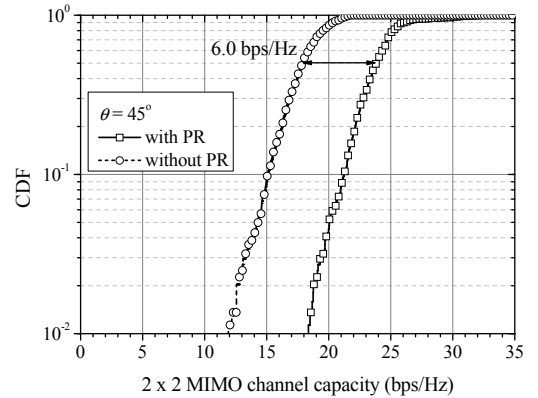

Figure 6 The CDF of the 2×2 MIMO channel capacity with/without 4-unit PR for $\theta = 45^\circ$ (received noise level=-120 dBm/Hz).

The channel capacity was also calculated for evaluating MIMO performance. Fig. 6 - Fig. 9 show the CDF of the 2×2 MIMO channel capacity with/without the 4-unit PR for $\theta = 45^\circ$ (received noise level=-90 dBm/Hz - -120 dBm/Hz with 10 dBm/Hz step). It is found that when the received noise level is supposed to be -120 dBm/Hz, the median of the MIMO channel capacity with the 4-unit PR is increased by 6 bps/Hz comparing with that of lack of the 4-unit PR. Moreover, the gain of the MIMO channel capacity will decrease with increasing the received noise level.

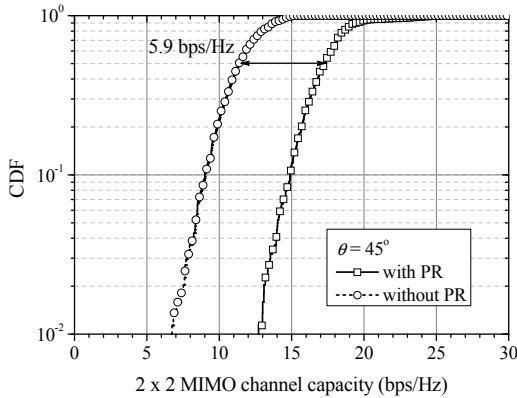

Figure 7 The CDF of the 2×2 MIMO channel capacity with/without 4-unit PR for $\theta = 45^\circ$ (received noise level=-110 dBm/Hz).

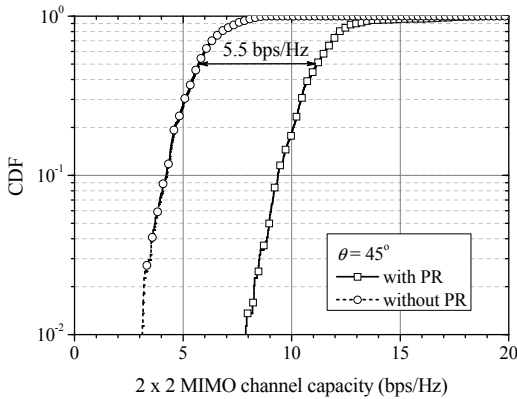

Figure 8 The CDF of the 2×2 MIMO channel capacity with/without 4-unit PR for $\theta = 45^\circ$ (received noise level=-100 dBm/Hz).

Similar conclusions for other polarization directions can also be drawn. In the case of $\theta = 90^\circ$, the gain of the received power and the MIMO channel capacity is smaller than that of other cases because of the cross polarization problem. Furthermore, it is found that the gain of the MIMO channel capacity is decreasing nonlinearly with the reduced received

power. The above experimental results demonstrate the effectiveness of the 4-unit PR for improving the channel quality in MIMO communications.

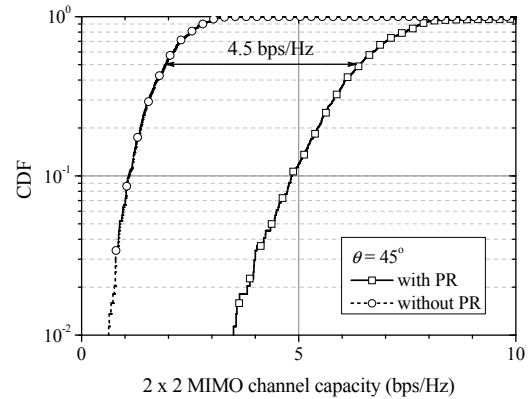

Figure 9 The CDF of the 2×2 MIMO channel capacity with/without 4-unit PR for $\theta = 45^\circ$ (received noise level=-90 dBm/Hz).

4. Conclusions

The 4-unit PR was fabricated to investigate experimentally the MIMO performance in multipath environments. Based on experimental results as obtained above, it was found that the received power and the MIMO channel capacity were improved clearly by using the 4-unit PR, which demonstrated the validity of the 4-unit PR for the practical applications to MIMO system. Furthermore, the gain of the MIMO channel capacity decreased with increasing the received noise level. At CDF = 0.5 ($\theta = 45^\circ$), about 14 dB improvement was obtained for the received power due to the existence of the 4-unit PR. When the received noise level was supposed to be -120 dBm/Hz, the median gain of the MIMO channel capacity was increased by 6 bps/Hz as well.

Acknowledgment

This work is partly supported by "The research and development project for expansion of radio spectrum resources" of The Ministry of Internal Affairs and Communications, Japan, and also partly supported by the ASIST (Cooperative Support Program for Asian IT Student Career Route in Japan) Program.

References

- [1] H. D. Hristov, R. Feick, and W. Grote, "Improving indoor signal coverage by use of through-wall passive repeaters," in *Proc. IEEE Antennas Propag. Soc. Int. Symp.*, vol. 2, pp. 158-161, 2001.
- [2] Y. Huang, N. Yi, and X. Zhu, "Investigation of using passive repeaters for indoor radio coverage improvement," in *Proc. IEEE Antennas Propag. Soc. Int. Symp.*, vol. 2, pp.

1623-1626, 2004.

- [3] L. Li, Q. Chen, Q. Yuan, K. Sawaya, T. Maruyama, T. Furuno, and S. Uebayashi, "Novel broadband planar reflectarray with parasitic dipoles for wireless communication applications," *IEEE Antennas Wireless Propagat. Lett.*, pp. 881-885, Aug. 2009.
- [4] Q. Chen, Q. Yuan, Shi-Wei Qu, and K. Sawaya, "Dual-antenna system composed of patch array and open-ended waveguide for eliminating blindness of wireless communications," *IEICE Electro. Express*, vol. 7, no. 9, pp. 647-651, May 2010.
- [5] S.-W. Qu, Q.-Y. Chen, Q. Chen, J. Li, Q. Yuan, and K. Sawaya, "Dual-Antenna System for Elimination of Blindness in Wireless Communications," *Progress In Electromagnetics Research (PIER) C*, vol. 21, pp. 87-97, 2011.
- [6] Lin Wang, Shi-Wei Qu, Jianfeng Li, Qiang Chen, Qiaowei Yuan, and Kunio Sawaya, "Experimental Investigation of MIMO Performance Using Passive Repeater in Multipath Environment," *IEEE Antennas Wireless Propag. Lett.*, vol. 10, pp. 752-755, 2011.
- [7] S. L. Yang, and K. Luk, "Wideband folded-patch antennas fed by L-shaped probe," *Microw. Opt. Tech. Lett.*, vol. 45, no. 4, pp. 352-355, May 2005.
- [8] H.-W. Lai, and K. Luk, "Design and study of wide-band patch antenna fed by meandering probe," *IEEE Trans. Antennas Propagat.*, vol. 54, no. 2, pp. 564-571, Feb. 2006.
- [9] R. A. Alhalabi, and G. M. Rebeiz, "High-efficiency angled-dipole antennas for millimeter-wave phased array applications," *IEEE Trans. Antennas Propagat.*, vol. 56, no. 10, pp. 3136-3142, Oct. 2008.